

Robin

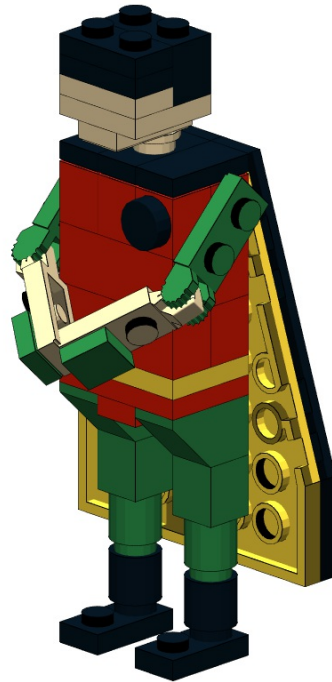

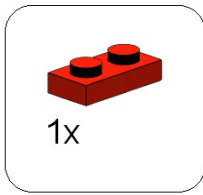

1

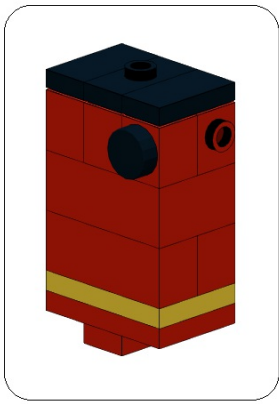
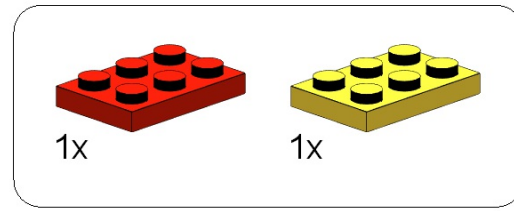

2

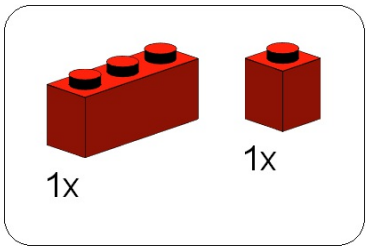
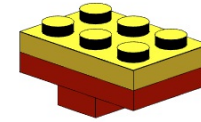
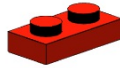

3

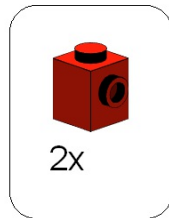
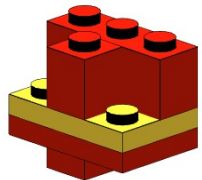

4

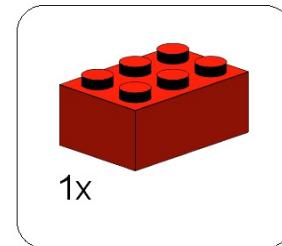
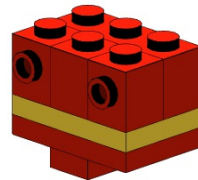

5

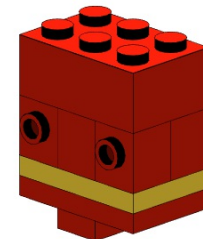

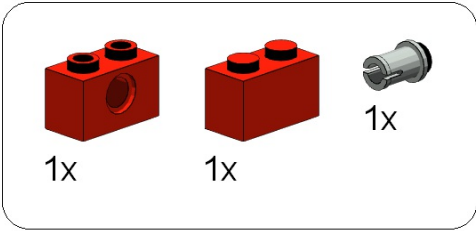

6

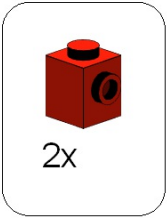
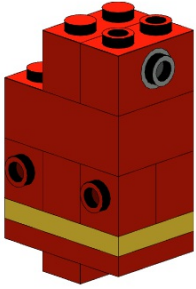

7

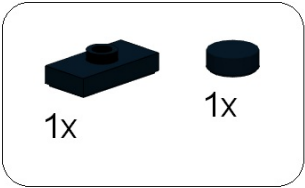
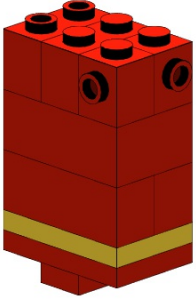
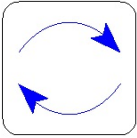

8

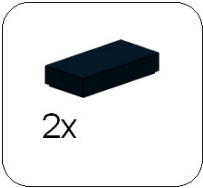
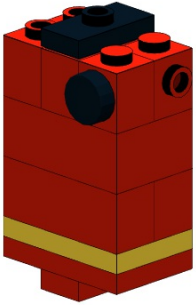

9

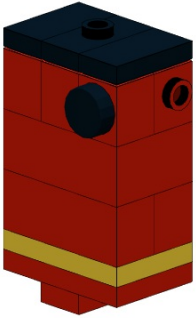

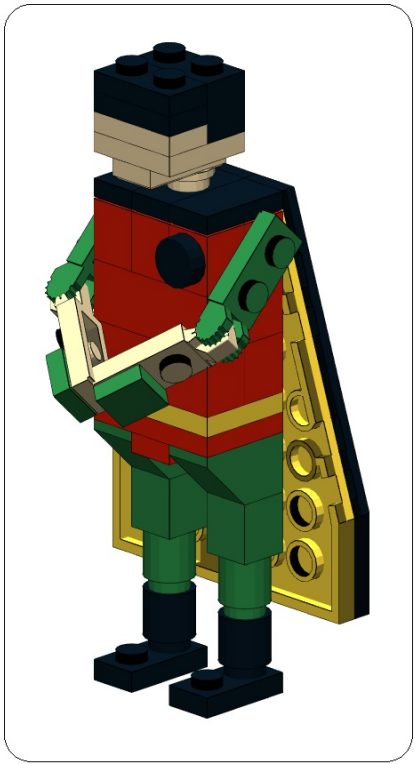

1

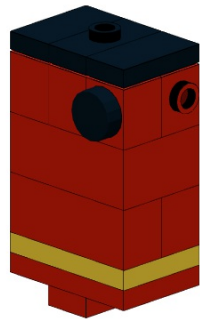

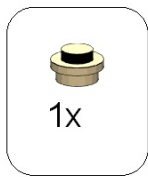
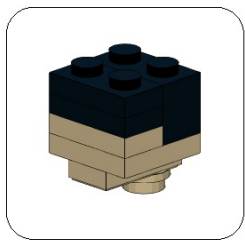

1x

1

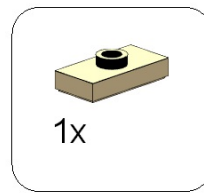

1x

2

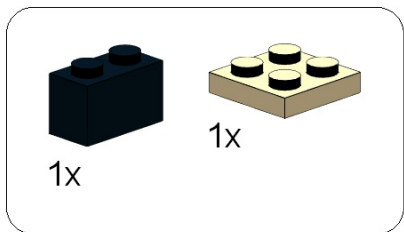
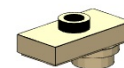

1x

1x

3

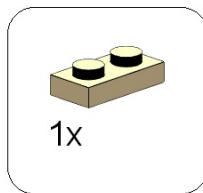
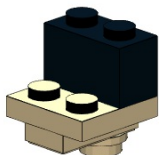

1x

4

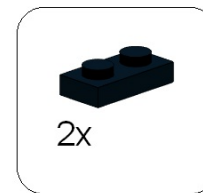
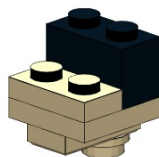

2x

5

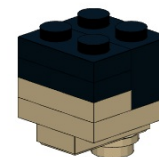

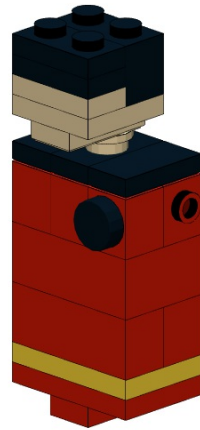

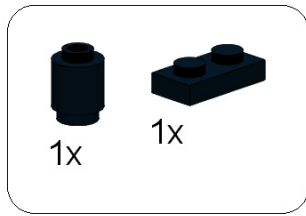
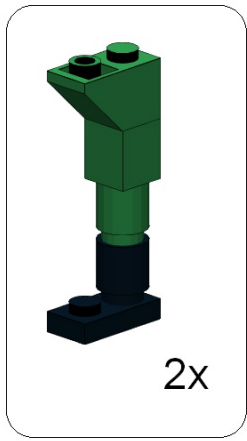

1

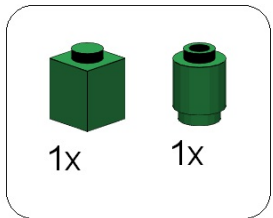
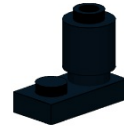

2

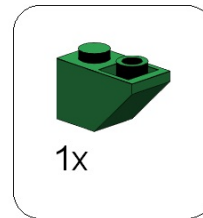
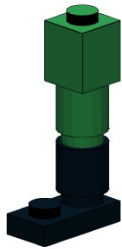

3

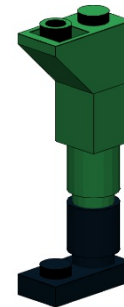

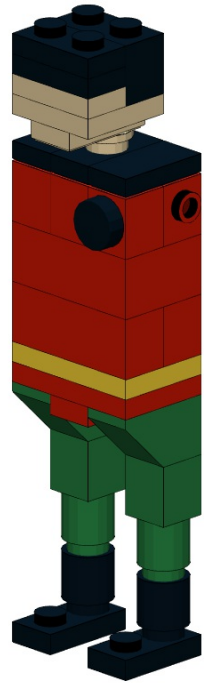



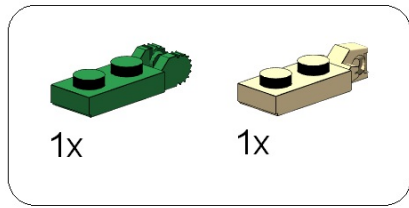
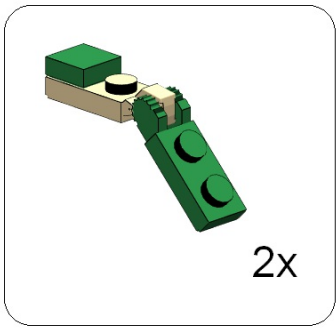

1

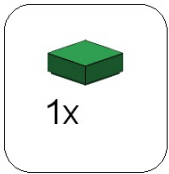
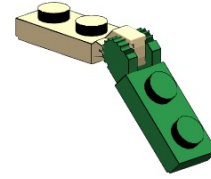

2

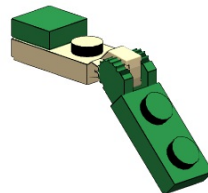

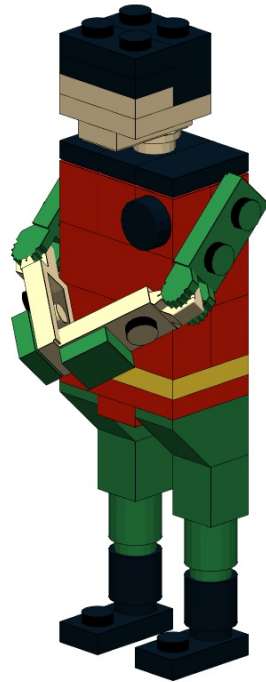

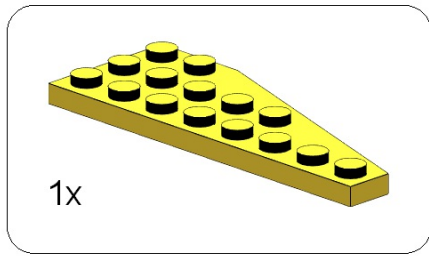
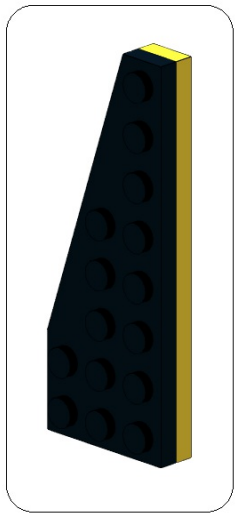

1

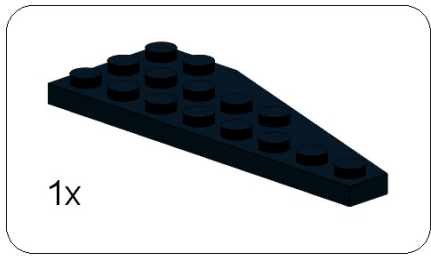
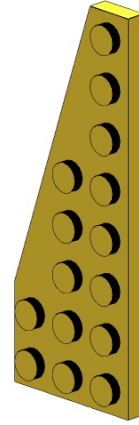

2



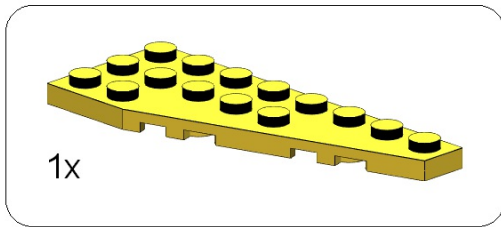
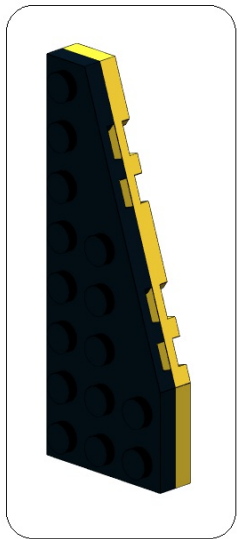

1x

1

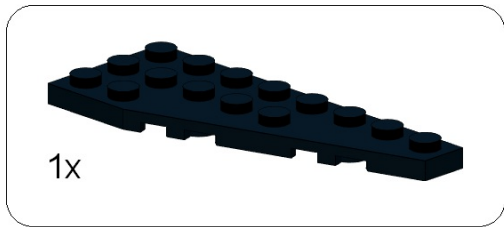
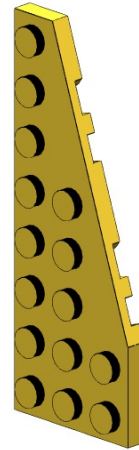

1x

2

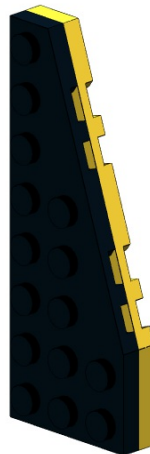

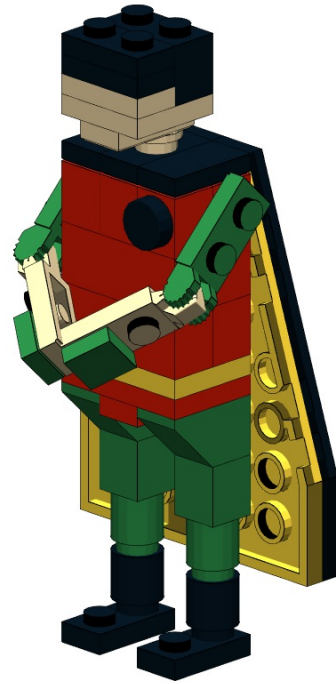



1x



2x



1x



2x

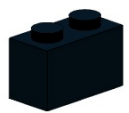

1x



4x

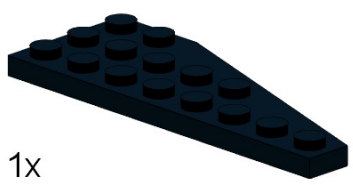

1x

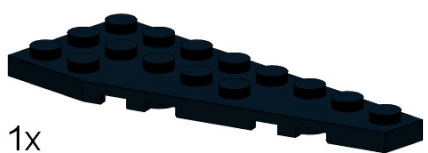

1x



2x



2x



2x

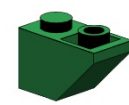

2x

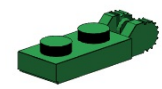

2x

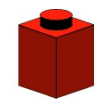

1x



4x

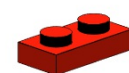

1x

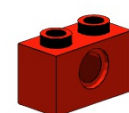

1x

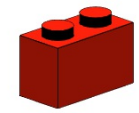

1x

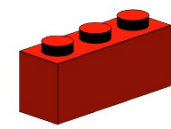

1x

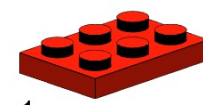

1x

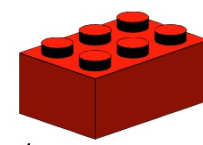

1x



1x

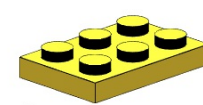

1x

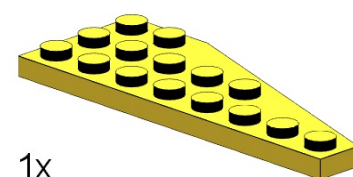

1x

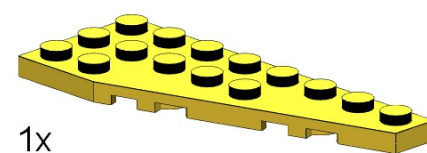

1x



1x

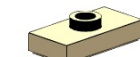

1x

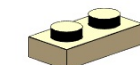

1x

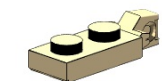

2x

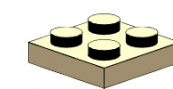

1x